

KED12主机传令钟系统 KED12 Engine telegraph system

设备组成 Device Composition

| 序号 S/N | 型号 Model | 名称 Name | 主要材质 Main material | 重量 Weight | 防护等级 IP class |
|-----------|-------------|--|-----------------------------|--------------|------------------|
| 1 | KED12-F-Q | 传令钟发信器 Telegraph transmitte | 阻燃ABS Fire retardant ABS | 1.18Kg | IP 20 |
| 2 | KED12-F-Q | 传令钟发信器(双) Telegraph transmitter(Double) | 阻燃ABS Fire retardant ABS | 1.4Kg | IP 20 |
| 3 | KED12-S-Q | 传令钟复示器 Telegraph repeater | 阻燃ABS Fire retardant ABS | 0.92Kg | IP 20 |
| 4 | KED12-S-Q | 传令钟复示器(双) Telegraph repeater(Double) | 阻燃ABS Fire retardant ABS | 0.8Kg | IP 20 |
| 5 | KED12-J-Q | 传令钟收信器 Telegraph receiver | 阻燃ABS Fire retardant ABS | 1.04Kg | IP 20 |
| 6 | KED12-J-Q | 传令钟收信器(双) Telegraph receiver(Double) | 阻燃ABS Fire retardant ABS | 0.8Kg | IP 20 |
| 7 | KED12-J-G | 传令钟收信器 Telegraph receiver | 阻燃ABS Fire retardant ABS | 1.06Kg | IP 44 |
| 8 | KY-1G | 电源盒 Power supply box | 碳钢 Carbon steel | 1.6Kg | IP 44 |
| 9 | KL-1AG | 闪光灯铃组 Relay box with light & bell | 阻燃ABS Fire retardant ABS | 0.9Kg | IP 44 |

传令钟发信器 Telegraph transmitter

功能描述

KED12型传令钟，采用微处理器，四芯电缆连接。
传令钟共分十一档，即前进微速、前进低速、前进半速、前进全速、停车、完车、备车、后退微速、后退低速、后退半速、后退全速。
发送器和接收器不同步时，发出声光报警。
具有失电报警、故障报警、误车报警等功能。
具有VDR接口。

Function

KED12 telegraph introduces microprocessor technology and four-core cable connection mode
Operation of telegraph consists of 11 steps such as ahead dead slow, ahead slow, ahead half, ahead full, stop, finish, standby, astern dead slow, astern slow, astern half and astern full.
When transmitter and receiver are not synchronous, it will send out audible and visual alarm.
Power failure alarm, fault alarm and error alarm
VDR interface

KED12-F-Q传令钟发信器 Telegraph transmitter



KED12-F-Q

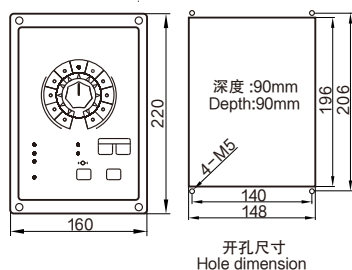

开孔尺寸
Hole dimension



KED12-F-Q(双)

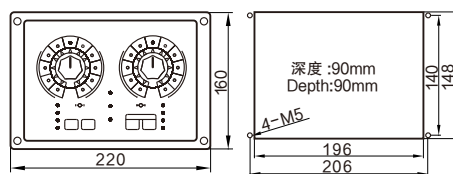

开孔尺寸
Hole dimension

主电源 Main power:DC24V ^{+30%}/_{-25%}
应急电源 Emergency power:DC24V ^{+30%}/_{-25%}
报警声压级 Alarm sound pressure level:80dB ~ 90dB
无源触点负载(阻性) Passive contact load (resistance):
2A/30VDC 1A/125VAC
无源触点最大切换电压 Maximum shift voltage of
passive contact:240VAC/120VDC
颜色 Color:黑色black (RAL 9005)
防护等级 IP class:IP20
重量 Weight:1.18/1.4Kg
功耗 Power:5W

KED12-S-Q传令钟复示器 Telegraph repeater

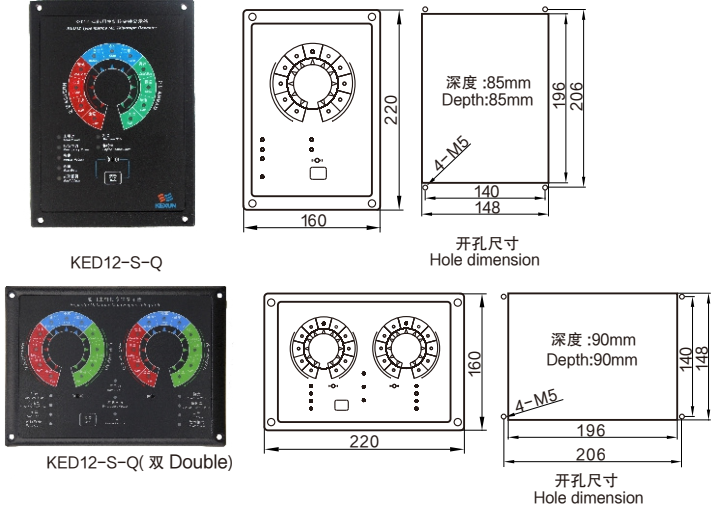

KED12-S-Q

深度:85mm
Depth:85mm

开孔尺寸
Hole dimension

KED12-S-Q(双 Double)

深度:90mm
Depth:90mm

开孔尺寸
Hole dimension

工作电压 Power supply:DC24V^{+30%}_{-25%}

报警声压级 Alarm sound pressure level:80dB ~ 90dB

颜色 Color:黑色black (RAL 9005)

防护等级 IP class:IP20

重量 Weight:0.92/0.8Kg

功耗 Power:5W

传令钟收信器 Telegraph receiver

功能描述

KED12型传令钟，采用微处理器，四芯电缆连接。
传令钟共分十一档。
在发信器和收信器不同步时，发出声光报警。
具有失电报警、故障报警、误车报警等功能。

Function

KED12 telegraph introduces microprocessor technology and four-core cable connection mode. Operation of telegraph consists of 11 steps. When transmitter and receiver are not synchronous, it will send out audible and visual alarm. Power failure alarm, fault alarm and error alarm.

KED12-J-Q传令钟收信器 Telegraph receiver

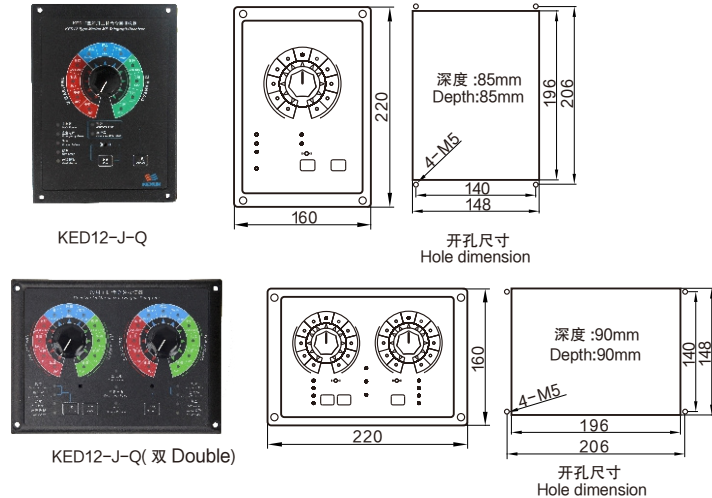

KED12-J-Q

深度:85mm
Depth:85mm

开孔尺寸
Hole dimension

KED12-J-Q(双 Double)

深度:90mm
Depth:90mm

开孔尺寸
Hole dimension

工作电压 Power supply:DC24V^{+30%}_{-25%}

报警声压级 Alarm sound pressure level:80dB ~ 90dB

无源触点负载(阻性) Passive contact load (resistance):
2A/30VDC 1A/125VAC

无源触点最大切换电压 Maximum shift voltage of passive contact:240VAC/120VDC

有源输出容量 Active output capacity:DC24V/1A

颜色 Color:黑色black (RAL 9005)

防护等级 IP class:IP20

重量 Weight:1.04/0.8Kg

功耗 Power:5W

KED12-J-G传令钟收信器 Telegraph receiver

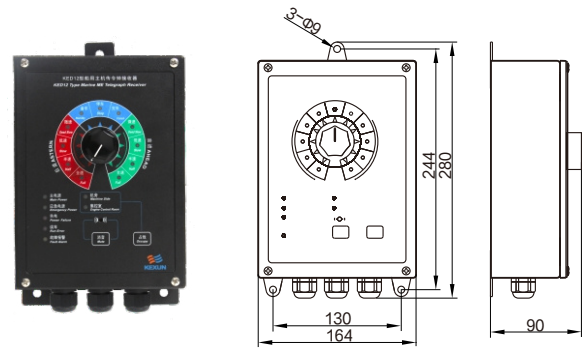

开孔尺寸
Hole dimension

工作电压 Power supply:DC24V^{+30%}_{-25%}

报警声压级 Alarm sound pressure level:80dB ~ 90dB

无源触点负载(阻性) Passive contact load (resistance):
2A/30VDC 1A/125VAC

无源触点最大切换电压 Maximum shift voltage of passive contact:
240VAC/120VDC

有源输出容量 Active output capacity:DC24V/1A

颜色 Color:黑色black (RAL 9005)

防护等级 IP class:IP44

重量 Weight:1.06Kg

功耗 Power:5W

填料函进线孔径 Stuffing box cable entrance hole size:3-Φ14mm

KY-1G电源盒 Power supply box

功能描述

用于AC--DC电源转换。

Function

Applied to transform AC220V to DC24V.

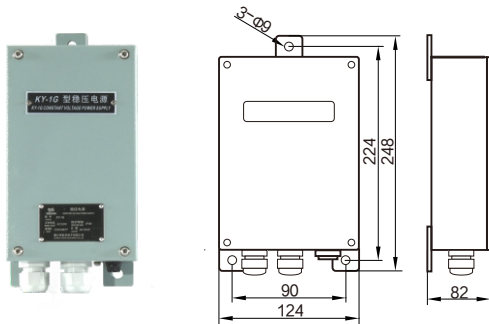

输入电压Input voltage: AC220V ± 10% 50/60Hz
 输出电压Output voltage: DC24V ^{+30%}/_{-25%}
 最大输出电流Maximum output current: 3A
 颜色Color: 中绿灰green gray (RAL 6034)
 防护等级 IP class: IP44
 重量 Weight: 1.6Kg
 填料函进线孔径 Stuffing box cable entrance hole size: 2-Φ14mm

KL-1AG闪光灯铃组 Alarm with light and buzzer

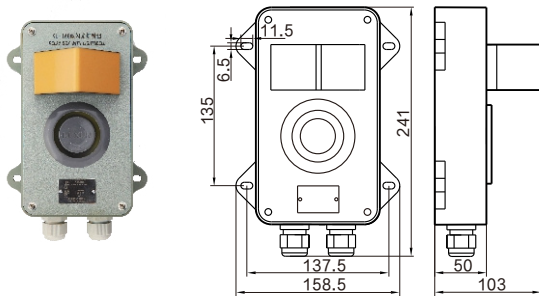

工作电压 Power supply: KL-1AG DC24V ^{+30%}/_{-25%}
 颜色 Color: 中绿灰green gray (RAL 6034)
 防护等级 IP class: IP44
 重量 Weight: 0.92
 报警声压级 Sound pressure level: 90dB ~ 105dB
 无源触点负载 (阻性) Passive contact load (resistance):
 2A/30VDC 1A/125VAC
 无源触点最大切换电压 Passive contact maximum switchover voltage:
 240VAC/120VDC
 填料函进线孔径 Stuffing box cable entrance hole size: 2-Φ12mm
 功耗 Power: 5W

KED12主机传令钟系统接线示意图 KED12 Main engine telegraph system connection diagram

KED12-F(单主机Single main unit)

发信器 — 复示器 — 收信器

Transmitter — Repeater — Receiver

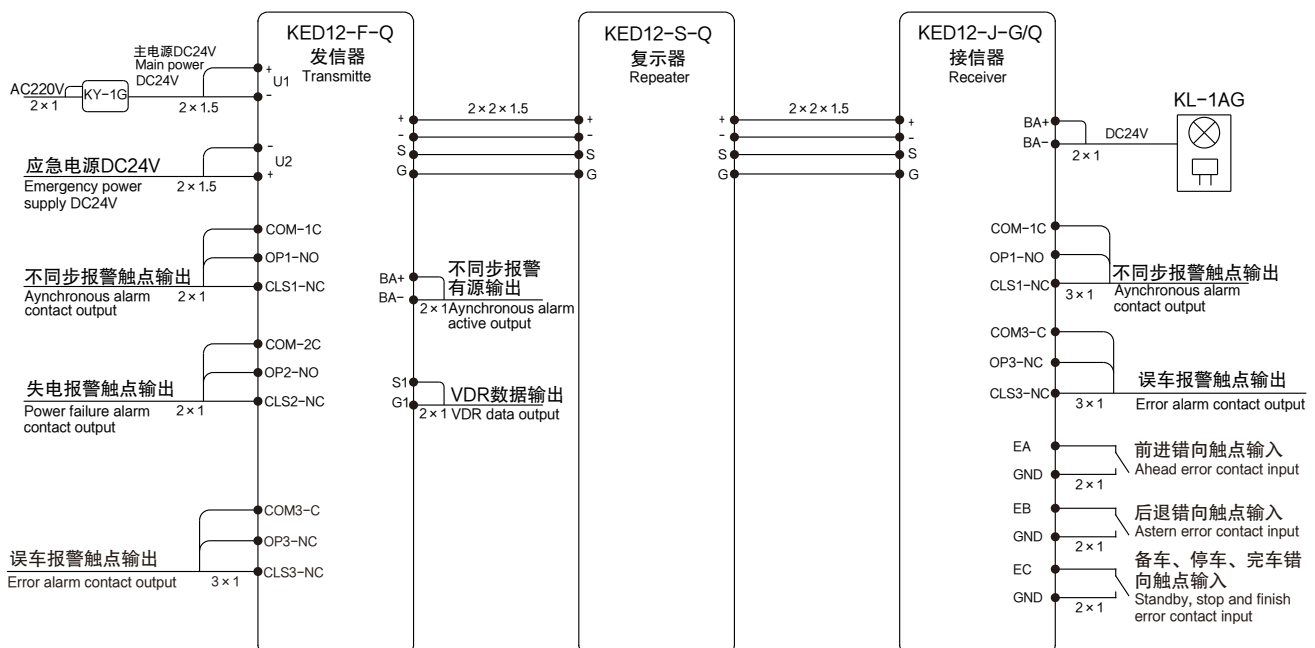

KED12主机传令钟系统接线示意图 KED12 Main engine telegraph system connection diagram

KED12-F(双主机Double main unit)

发信器 — 复示器 — 收信器

Transmitter — Repeater — Receiver

