

K1302 系列火灾报警系统 Fire alarm system

设备组成 Device Composition

序号 S/N	型号 Model	名称 Name	主要材质 Main material	重量 Weight	防护等级 IP class
1	K1302A	火灾报警控制器(嵌入式) Fire alarm control panel(Flush type)	碳钢 Carbon steel	10Kg	IP22
		火灾报警控制器(壁挂式) Fire alarm control panel(Wall mount)		9.9Kg	IP44
2	K1303	火灾复示器(嵌入式) Fire alarm repeater(Flush type)	阻燃ABS Fire reatardant ABS	1.1Kg	IP20
		火灾复示器(壁式) Fire alarm repeater(Wall mount)		1.8g	IP22/IP44/IP56
3	J-SAP-M-M900K	手动报警按钮 Manually operated call point	阻燃ABS Fire reatardant ABS	300g	IP22/IP44/IP56
4	J-SAB-M-M500KEIS	防爆手动报警按钮 Explosion-proof manually operated call point	阻燃ABS Fire reatardant ABS	300g	IP20/IP44
5	JTW-BD-ZR875H/T	感温探测器(90℃) Watertight detector pedestal	阻燃ABS Fire reatardant ABS	100g	IP20/IP44
6	JTW-BD-ZM995	感温探测器(60℃) Heat detector	阻燃ABS Fire reatardant ABS	100g	IP20/IP44
7	JTWB-BCD-5151EIS	感温探测器(防爆) Heat detector(Explosion-proof)	阻燃ABS Fire reatardant ABS	100g	IP20/IP44
8	JTY-GD-ZM992	感烟探测器 Smoke detector	阻燃ABS Fire reatardant ABS	100g	IP20/IP44
9	JTY-GD-2151EIS	感烟探测器(防爆) Smoke detector(Explosion-proof)	阻燃ABS Fire reatardant ABS	100g	IP20/IP44
10	BK8005WP	中继模块 Relay module	阻燃ABS Fire reatardant ABS	700g	IP44
11	KNS9007	齐纳安全栅 Safety barrier	阻燃ABS Fire reatardant ABS	700g	IP44
12	KTM-4	定时器 Timer	阻燃ABS Fire reatardant ABS	1.6g	IP44
13	M902C	输入输出模块 Output & input module	阻燃ABS Fire reatardant ABS	700g	IP44
14	M902M	接口模块 Interface module	阻燃ABS Fire reatardant ABS	700g	IP44
15	FS-1	探测器防水底座 Watertight detector pedestal	阻燃ABS Fire reatardant ABS	600g	IP44
16	DZ-B901	隔离底座 Isolator pedestal	阻燃ABS Fire reatardant ABS	100g	IP44

功能描述 Function

火灾报警探测器接线方式: 2总线制
 最大回路数量: 4(每个回路160点)
 历史记录功能: 火灾报警历史记录、故障报警历史记录、屏蔽历史记录、监管历史记录、启动历史记录、其它历史记录(包括开、关机, 复位等) 每种记录999条。
 输出端口: DC30V/1A
 a) 即时报警输出: 报警时输出无源触点。
 b) 二分钟延时报警输出(供通用报警板): 报警时输出无源触点。
 c) VDR输出接口(二线--RS485串口)
 联动编程数: 共12条
 内置蓄电池

主要技术参数 Main Technical Data

工作电源: 主电源: AC220V±10%, 50Hz/60Hz±5%。
 应急电源: DC24V 或AC220V±10%,50Hz/60Hz±5%。
 电池(选配): DC24V±4V。
 功耗: 静态: ≤5W,
 报警状态: ≤12W(25个探测器同时处于火警状态)
 报警声压级为: 75dB~95dB。
 输出触点容量: DC30V/1A。

Function

Fire alarm detector wiring: 2 bus system
 Maximum number of loops: 4 (each loop less than 160pcs)
 Function of historical record: fire alarm history record, fault alarm history record, Block history, regulatory history, activation history, and other history record (including on, off, reset, etc.) each record 999.
 Output port: DC30V/1A
 a) instant alarm output: passive contact is output when alarming.
 b) two-minute delay alarm output (for general alarm panel): passive contact is output when alarming.
 c) VDR output interface (two-wire --RS485 serial port)
 Linkage programming number: 12 in total
 Built-in battery

Power supply:
 Main power supply: AC220V ± 10%, 50Hz/60Hz ± 5%
 Emer. power supply: DC24V or AC220V ± 10%, 50Hz/60Hz ± 5%
 Battery (optional): DC24V ± 4V
 Power consumption: static state: ≤5W, alarm state: ≤12W
 (25pcs detector is in fire state at same time)
 Alarm sound level: 75dB ~ 95dB
 Output contact capacity: DC30V/1A

系统方案 System solution

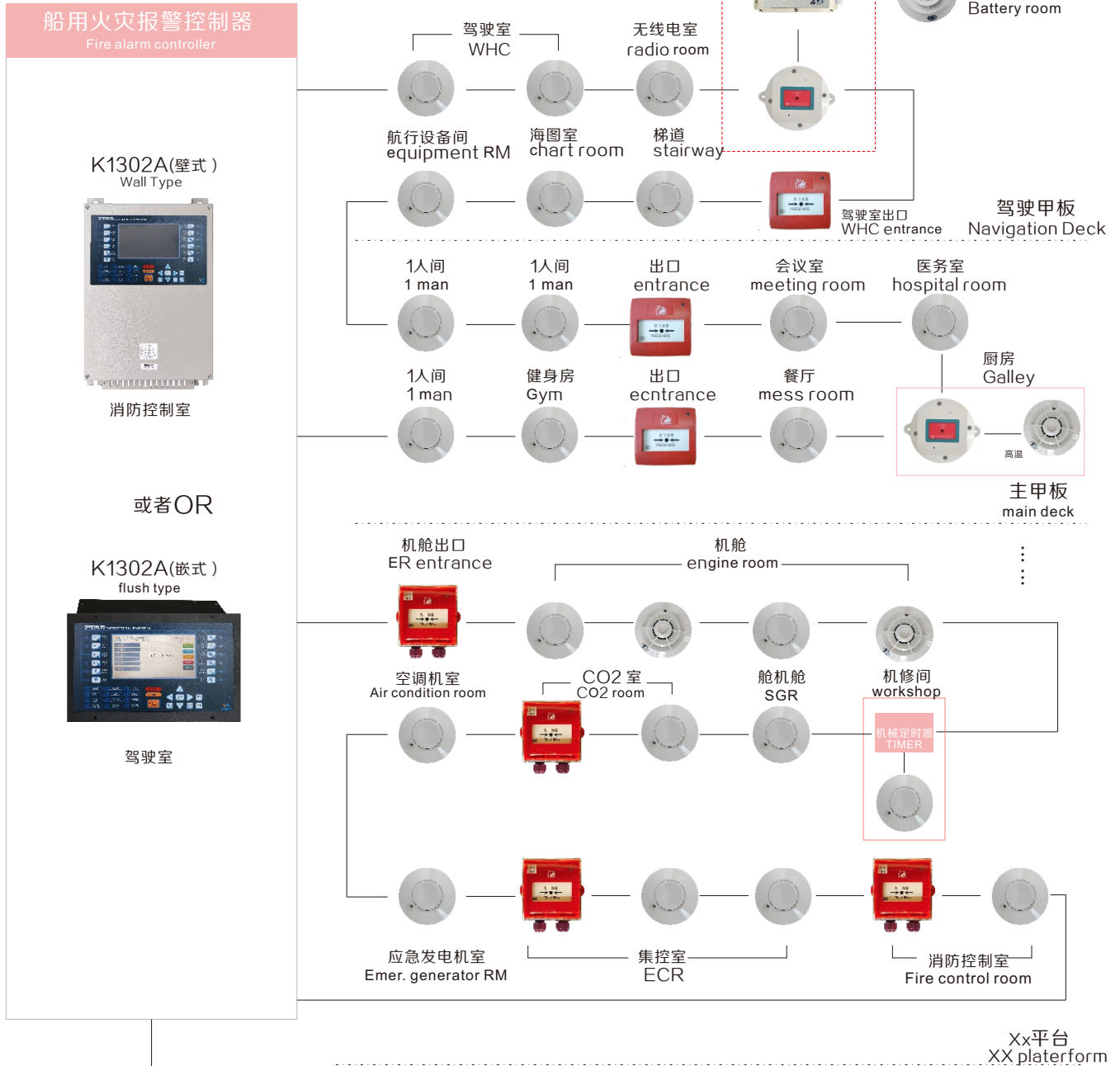

火警复示器
Fire alarm repeater
集控室(ECR)

图标说明 Illustration

-  感烟探测器
smoke detector
-  防爆感温探测器
Ex heat detector
-  防水手动报警按钮
W.T manual call point
-  感温探测器(60°C/90°C)
Heat detector(60°C/90°C)
-  防爆感烟探测器
Ex smoke detector
-  防爆手动报警按钮
Ex manual call point
-  中继模块
relay moule
-  手动报警按钮
manual call point

K1302系列火灾报警控制 器FIRE ALARM CONTROLLER

产品外观 Product picture		
用途 Purpose	中大型船舶 Medium and large vessels	适用小型船艇 For Small Fishing Boat
安装方式 Installation	嵌式 flush type	
主电源 Main power	AC220V±10%, 50Hz/60Hz±5%	
应急电源 EM'CY power	DC24V 或AC220V±10%,50Hz/60Hz±5%	DC24V
电池 Battery	DC24V±4V	-
功耗 Power consumption	报警状态: ≤12W 静态: ≤5W	
最大回路数量 Max. loop	4	1
回路最大传输距离 Max. loop distance	1000m	
防护等级 IP grade	IP22	IP20
产品外观 Product picture		
用途 Purpose	中大型船舶 Medium and large vessels	适用小型船艇 For Small Fishing Boat
安装方式 Installation	壁式 wall type	
主电源 Main power	AC220V±10%, 50Hz/60Hz±5%	
应急电源 EM'CY power	DC24V 或AC220V±10%,50Hz/60Hz±5%	DC24V
电池 Battery	DC24V±4V	-
功耗 Power consumption	报警状态: ≤12W 静态: ≤5W	
最大回路数量 Max. loop	4	1
回路最大传输距离 Max. loop distance	1000	
防护等级 IP grade	IP44	

K1303 火灾报警复示器 FIRE ALARM REPEATER

产品外观
Product picture



型号 Model	K1303	
安装方式 Installation	嵌式 flush type	壁式 wall type
功耗 Power consumption 与控制器线路长度 With the controller line length	静态: ≤1.5W 报警状态: ≤2.4W	
回路最大传输距离 Maximum loop transmission distance	1000m	
防护等级 IP grade	IP20	IP44

外形尺寸 Outline drawing

K1302系列壁式火灾报警控制器
Fire alarm controller(wall type)

K1302系列嵌式火灾报警控制器
Fire alarm controller(Flush type)

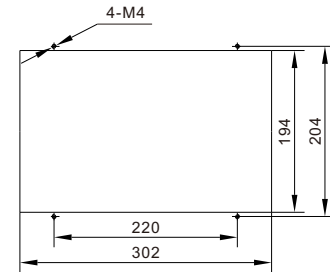
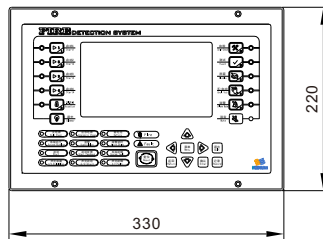
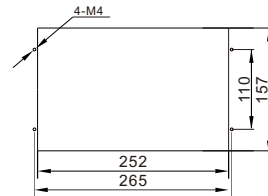
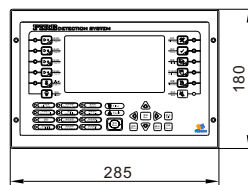
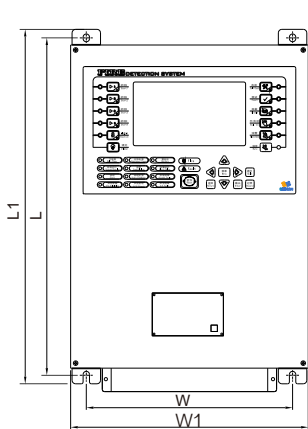

安装尺寸 Mounting size

L	L1	W	W1	H
474	498	290	334	97.5
324	359	210	250	100



开孔尺寸: cut-hole size

K1303 嵌式火灾报警复示器
Fire alarm repeater(Flush type)

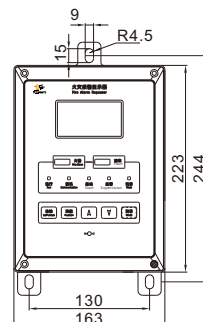
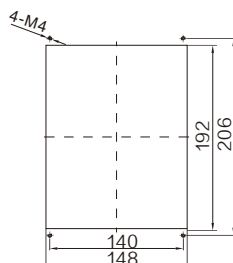
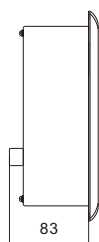
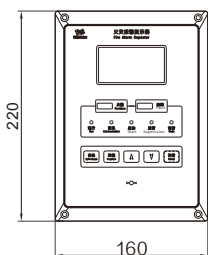
K1303 壁式火灾报警复示器
Fire alarm repeater(wall type)



火灾报警探测器 Fire alarm detector

名称 NAME	感烟探测器 Smoke Detector	感温探测器 Heat Detector	防爆感烟探测器 Ex Smoke Detector	防爆感温探测器 Ex Heat Detector
产品外观 Product picture				
型号 Model	JTY-GD-ZM992	JTY-GD-ZM995, JTW-BD-ZR875H/T	JTWB-BCD-5151EIS	JTY-GD-2151EIS
灵敏度 Sensitivity	Class I, Class II	60°C, 90°C	Class II	63°C
监视电流 Monitor current	≤450μA	≤700μA	≤100μA	≤60μA
报警电流 Alarm current	≤3.5mA	≤3mA	≤10mA	≤130mA
防爆等级 Ex rating	-	-	Ex ib II CT6 Gb	
工作电压 Working voltage	DC15V~32V		DC15V~28V	
外壳材质 Hull material	ABS 阻燃 ABS fire resistance			
颜色 Colour	乳白 cream-colored			

探测器底座 Detector pedestal

名称 NAME	防水探测器底座 Watertight detector pedestal	隔离底座 Isolator pedestal
产品外观 Product picture		
型号 Model	FS-1	DZ-B901
功能描述 functional description	与感温、感烟、防爆感烟、防爆感温探测器配套使用, 满足防水等级要求 It is matched with heat detector, smoke detector, explosion-proof smoke and heat detector to meet the requirements of waterproof grade	与感温、感烟探测器配套使用, 满足隔离功能 It is matched with heat detector, smoke detector to meet the isolation function.
外壳材质 Hull material	阻燃 ABS fire resistance	
填料函进线孔径 Cable gland entry demension	2-φ10~14mm	-
颜色 Colour	白色	

FS-1 防水底座
Watertight debase

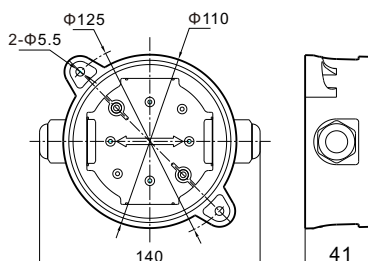

DZ-B901 隔离底座
Isolator detector

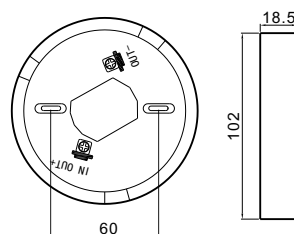

外形尺寸
Outline drawing



手动报警按钮 Manually call point

功能描述

与控制器间二总线传送人工报警信号。
工作稳定可靠，适用范围广。
采用编码器进行写入式地址编码，不再使用拨码开关。
使用复位钥匙复位，无需更换操作面板。
超薄型结构设计。

Function

Manual alarm signals are transmitted between the 2 buses and controller.
Stable and reliable work, wide range of application.
Use encoder to write address encoding, no longer use the dial code switch.
Use the reset key to reset without replacing the operation panel.
Ultra-thin structure design.

名称 Name	手动火灾报警按钮 Manual fire call point	手动火灾报警按钮 Manual fire call point	防水手动火灾报警按钮 W.T manual fire call point	防爆手动火灾报警按钮 Ex Manual fire call point
产品外观 Product picture				
型号 Model	J-SAP-M-M900K	J-SAP-M-M900K	J-SAP-M-M900K	J-SAB-M-M500KEIS
工作电压 Working voltage	DC15V~30V			
静态功耗 Static power loss	≤1.5MA			
防爆等级 Ex rating	-	-	-	Exib II CT5 Gb
防护等级 IP class	IP22	IP44	IP56	IP44
填料函进线孔径 Cable gland entry demension	2-Φ6~12mm			
外壳材质 Hull material	阻燃ABS fire resistance			
颜色 Colour	红 Red			

外形尺寸 Outline drawing

J-SAP-M-M900K 手动火灾报警按钮
Manual fire call point

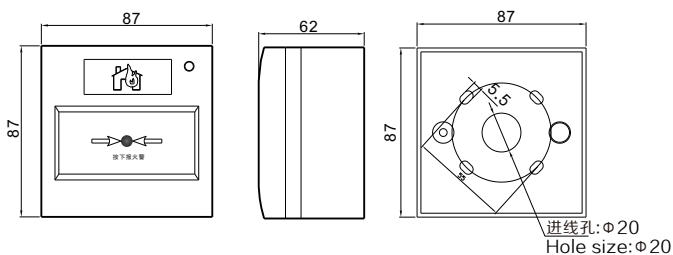

J-SAP-M-M900K 手动火灾报警按钮
Manual fire call point(IP44)

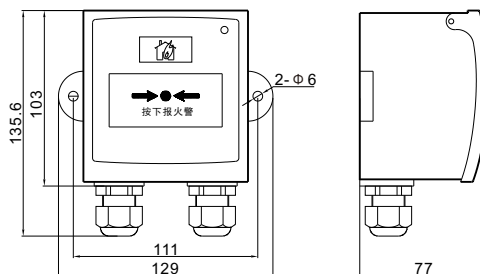

J-SAP-M-M900K 手动火灾报警按钮
W.T Manual fire call point(IP56)

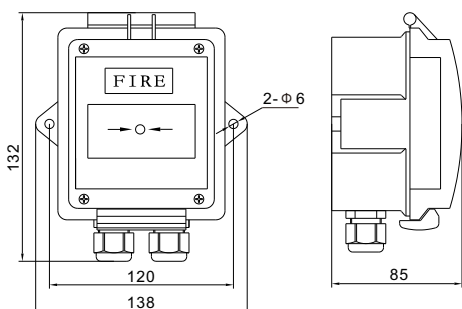

J-SAB-M-M500KEIS 手动火灾报警按钮
Ex Manual fire call point

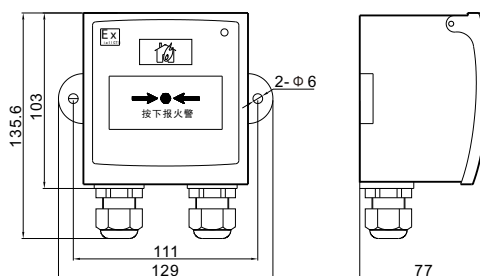

名称 Name	齐纳安全栅 Safety zener barrier	输入输出模块 Input&output module	中继模块 Relay module
产品外观 Product picture			
型号 Model	KNS9007	M902C	BK8005WP
功能描述 Function description	用于防爆探测器或防爆按钮支路,连接在防爆探测器或防爆按钮前面。 安装在安全区域。 For explosion-proof detector or call point .be connected before explosion-proof detector or call point. Be mounted in safety area.	用于联动控制现场设备,如排风阀、送风阀、防火阀等。模块采样电子编码,动作时输出有源或无源信号。 Used for linkage control field equipment, such as exhaust valve, air supply valve, fire valve, etc.Module sampling electronic code, action output active or passive signal.	主要用于连接非编码两线制传统探测器。该模块为总线编码型,该模块为所接非编码探测器提供工作电源,同时将探测器故障、报警、线路短路断路等信息传递给火灾报警控制器。 used for connecting non-coding two-wire traditional detectors.The module is of bus coding type, which provides working power for the connected non-coding detector and transmits the detector fault, alarm, circuit break and short circuit information to the fire alarm controller.
外壳材质 Hull material	阻燃 ABS fire resistance		
颜色 Colour	白色 White		
重量 Weight	0.7Kg	0.7Kg	0.7Kg
填料函进线孔径 Cable gland entry demension	3-Φ12mm	3-Φ14mm	3-Φ12mm
防护等级 IP class	IP44	IP44	IP44
防爆等级 Ex marking	-	-	[Exia] IIC
名称 Name	机械定时器 Timer		
产品外观 Product picture			
型号 Model	KTM-1(for APOLLO)	KTM-4(for K1302)	
功能描述 Function description	用于探测器支路,连接在感温探/感烟探测器前面,通常安装在机修间,KTM-4和KTM-1用于编码探测器 KTM-1仅用于阿波罗火警,KTM-4用于K1302系列火警 Connect the smoke detector or the front of the temperature detector. Usually installed in a machine shop.KTM-4 and KTM-1 are used with coded detectors. KTM-1 is only used for Apollo fire alarm and KTM-4 is used for K1302 series fire alarm.		
外壳材质 Hull material	碳钢 Carbon steel	阻燃 ABS fire resistance	
颜色 Colour	中绿灰 grey	白色 White	
重量 Weight	1.6Kg	0.7Kg	
填料函进线孔径 Cable gland entry demension	2-φ10~14mm	3-φ10~14mm	
防护等级 IP class	IP44		

外形尺寸 Outline drawing

KN9007齐纳安全栅
Safety zener barrier

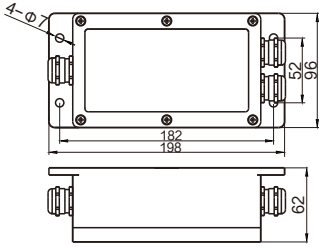

BK8005WP 中继模块
Relay module

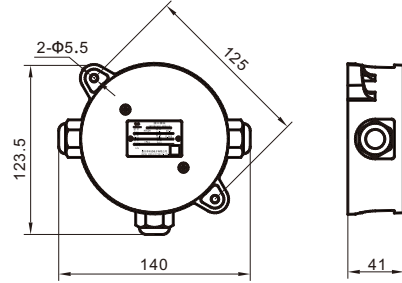

KTM-1 机械定时器
Timer

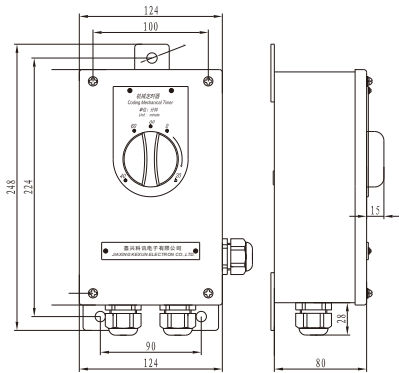

KTM-4 机械定时器
Timer

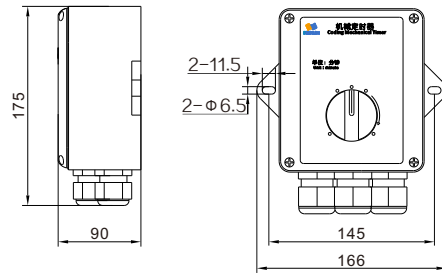

M902C输入输出模块
Input&output module

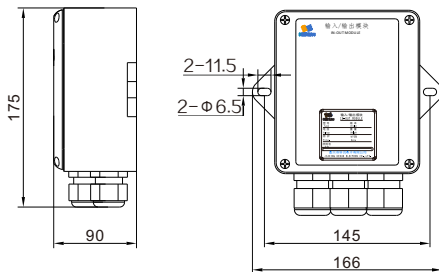

K1302A 火灾报警系统接线示意图

K1302A fire alarm system connection diagram

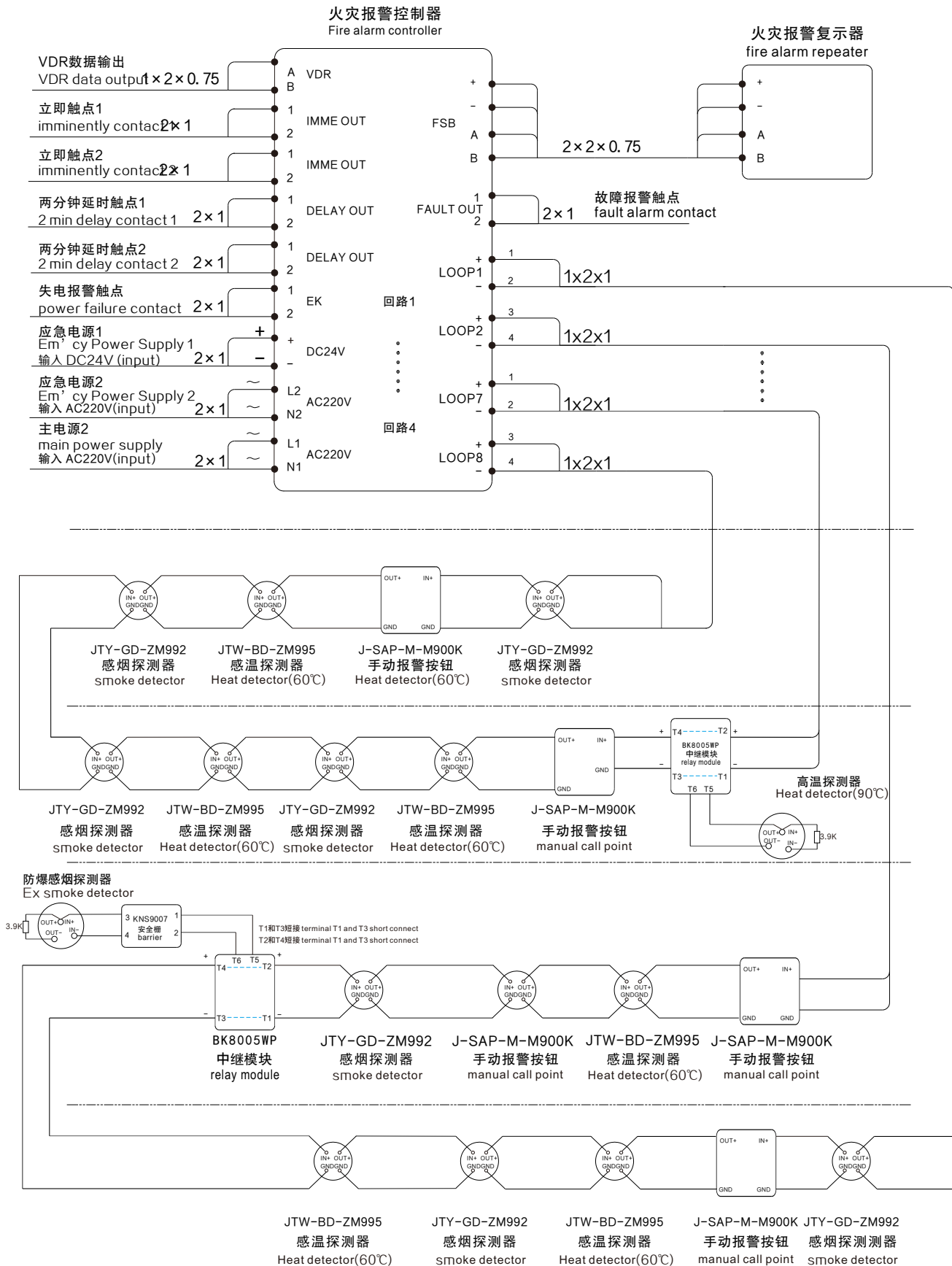

阿波罗防火探测器有限公司
UK Apollo fire detector Co., Ltd.火灾报警系统
fire alarm system

设备组成 Device Composition

序号 S/N	型号 Model	名称 Name	主要材质 Main material	重量 Weight	防护等级 IP class
1	Syncro ASM	火警报警控制器 Fire alarm control panel	碳钢 Carbon steel	9.5Kg	IP30
2	Syncro View	火警报警复示器(嵌入式/壁挂式) Fire alarm repeater(flush/wall mount)	碳钢 Carbon steel	9.5Kg	IP30
3	K1302A	火警报警控制器(嵌入式/壁挂式) Fire alarm control panel(flush/wall mount)	碳钢 Carbon steel	9.5Kg	IP30
4	K1303	火灾复示器(嵌入式/壁挂式) Fire alarm repeater(Flush type/wall mount)	阻燃ABS Fire reatardant ABS	9.5Kg	IP30
5	58000-600MAR+ 45681-286MAR	感烟探测器(带隔离器底座) Smoke detector(with isolator base)	阻燃ABS Fire reatardant ABS	160g	IP 44
6	58000-600MAR+ 45681-286MAR 45681-217	防水感烟探测器(带隔离器底座) Waterproof smoke detector(with isolator base)	阻燃ABS Fire reatardant ABS	160g	IP 44
7	58000-400MAR+ 45681-286MAR	感温探测器(60℃)(带隔离器底座) Heat detector(60℃)(with isolator base)	阻燃ABS Fire reatardant ABS	160g	IP 54
8	58000-400MAR+ 45681-286MAR 45681-217	防水感温探测器(60℃)(带隔离器底座) Waterproof heat detector(60℃)(with isolator base)	阻燃ABS Fire reatardant ABS	160g	IP 54
9	58000-400MAR+ 45681-286MAR 45681-217	防水感温探测器(90℃)(带隔离器底座) Waterproof heat detector(90℃)(with isolator base)	阻燃ABS Fire reatardant ABS	160g	IP 54
10	55000-640APO	防爆感烟探测器 Explosive smoke detector	阻燃ABS Fire reatardant ABS	300g	IP 44
11	55000-440APO	防爆感温探测器 Explosive heat detector	阻燃ABS Fire reatardant ABS	300g	IP 44
12	55000-855	协议通讯转换器 Protocol translator	阻燃ABS Fire reatardant ABS	1.0Kg	IP 44
13	KNS9007	安全栅 Barrier	阻燃ABS Fire reatardant ABS	100g	IP 44
14	55100-940APO	防爆手动报警按钮 Explosion-proof manul call point	阻燃ABS Fire reatardant ABS	240g	IP 67
15	58100-971MAR	手动报警按钮(带隔离) Manul call point(with isolator base)	阻燃ABS Fire reatardant ABS	160g	IP 24
16	58100-976MAR	防水手动报警按钮(带隔离) Waterproof manul call point(with isolator base)	阻燃ABS Fire reatardant ABS	160g	IP 67

阿波罗火灾探测器有限公司自1980年致力于设计和生产高质量火灾探测产品。那时，公司从传统的火灾探测器扩展至火灾探测系统的多种模拟编码探测器、监测接口和控制设备的生产。

阿波罗采用最先进的生产技术并投入精密的生产设备以确保一直生产出高质量的产品并快速响应客户的要求。通过计划扩展，阿波罗在火灾探测市场上达到全球领先地位。

嘉兴科讯有限公司是阿波罗指定中国代理商。

Apollo Fire Detectors Ltd has specialised in the design and manufacture of high quality fire detection products since 1980. In that time, the company has broadened its capability from a straightforward focus on conventional fire detectors to include the manufacture of sophisticated analogue addressable detectors and interfaces for monitoring and controlling equipment in fire protection systems.

Apollo applies the most modern production techniques and has invested in sophisticated manufacturing equipment to ensure consistent high quality products and fast response to customer requirements. Through planned expansion, Apollo has reached a leading global position in the market for professional fire detection.

China and Germany along with direct trade into more than 100 countries, Apollo has cemented its position as a world-class fire solutions provider.

Jiaxing Kexun Electron Co., Ltd. is China agent of Apollo.

Syncro火灾报警控制器 Fire alarm control panel

功能描述

地址编码型控住器。
液晶屏显示各报警点火警、故障等信息。
内置蓄电池。
即时报警、延时报警、故障报警三组无源触点。
VDR接口(RS485)。

Function

Addressable controller.
LCD will show fire alarm and fault of alarm point.
Built-in battery.
Three groups of passive contact of real-time alarm, delay alarm, fault alarm.
VDR interface(RS485)

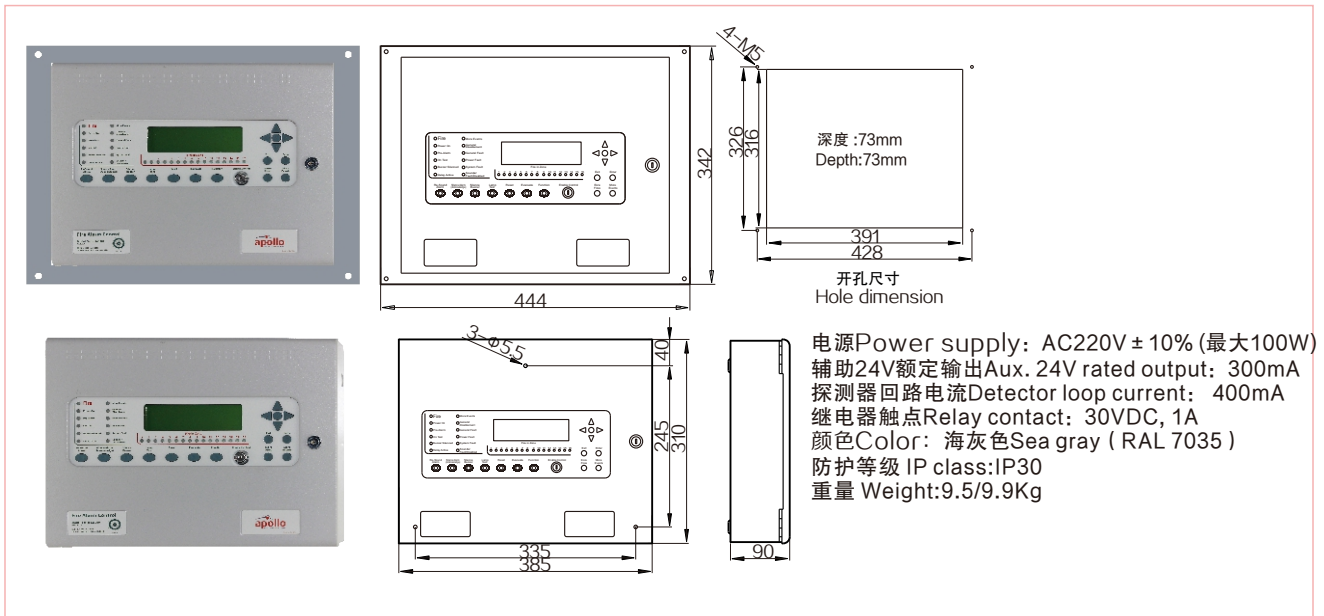

Syncro火灾报警复示器 Fire alarm repeater

功能描述

与地址编码型控制器配套使用。
液晶屏显示各报警点火警、故障等信息。

Function

Match with addressable controller.
LCD will show fire alarm and fault of alarm point.

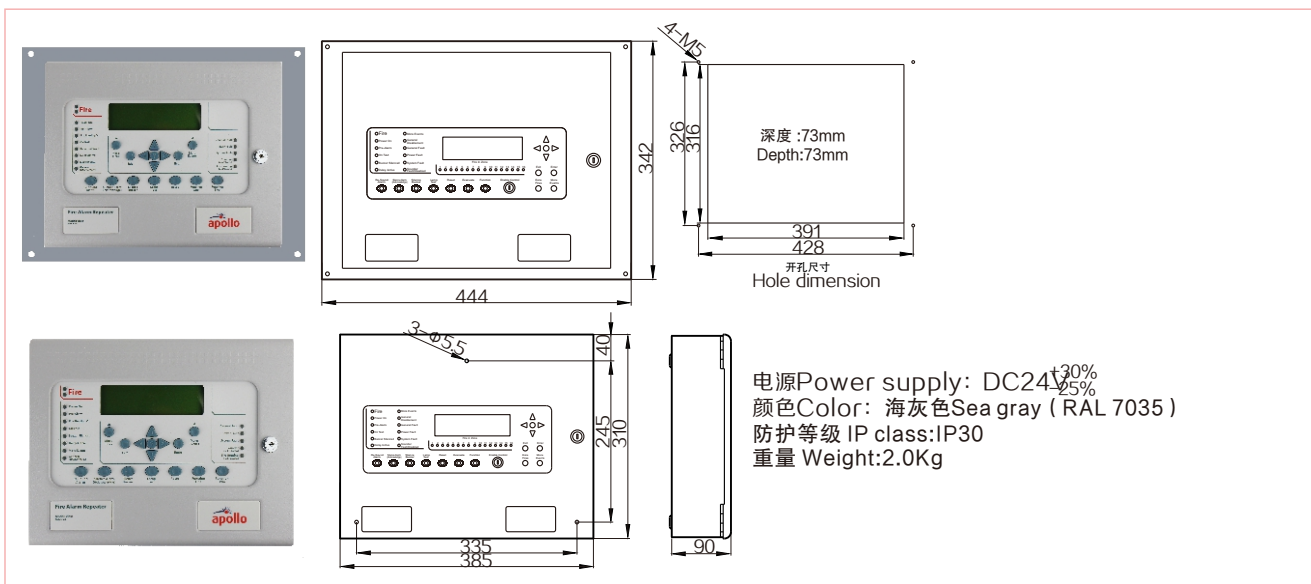

火灾报警探测器 Fire alarm detector

功能描述

与控制器间二总线传送报警信号。
工作稳定可靠, 适用范围广。

Function

It will transmit alarm signal to controller via 2-bus.
Working is stable and reliable; wide application range.
Reset by reset key and it is unnecessary to replace operation panel.

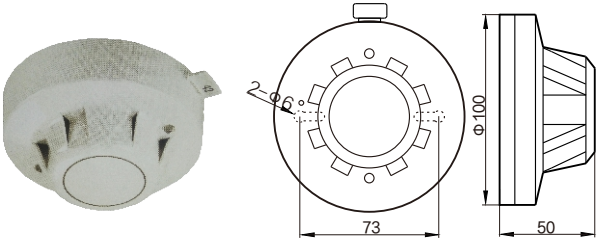

58000-600MAR+感烟探测器Smoke detector
58000-400MAR+感温探测器Heat detector
55000-640APO防爆感烟探测器Explosive smoke detector
55000-440APO防爆感温探测器Explosive heat detector
工作电压Operation voltage:DC17V~28V
静态电流Quiescent current:300~400uA
报警电流Alarm current:3.5mA
颜色Color: 白色white(RAL 1013)
防护等级 IP class:IP44
重量 Weight:160g
防爆等级Explosion-proof class:Exia II CT5

55000-855协议通信转换器 Protocol translator

功能描述

配防爆设备使用。

Function

Match with explosion-proof equipment.

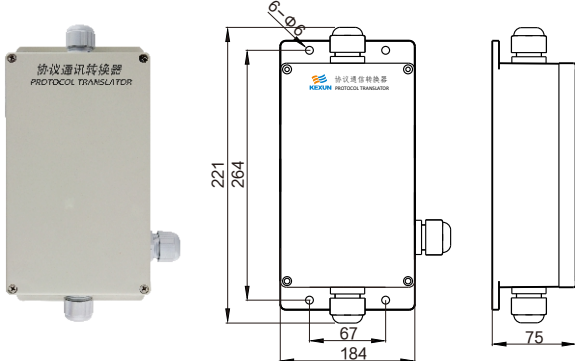

接线方式Supply wiring:Two wire supply,polarity sensitive
回路电压Supply voltage:19~28V
输出电压Output voltage(to barrier):16.5~19V
颜色Color: 白色white(RAL 1013)
防护等级 IP class:IP44
重量 Weight:1.0Kg
填料函进线孔径 Stuffing box cable entrance hole size: 3-Φ 14mm

58100-971MAR手动报警按钮 Manually call point

功能描述

与控制器间二总线传送人工报警信号。
工作稳定可靠, 适用范围广。
使用复位钥匙复位, 无需更换操作面板。

Function

It will transmit manual alarm signal to controller via 2-bus.
Working is stable and reliable; wide application range.
Reset by reset key and it is unnecessary to replace operation panel.

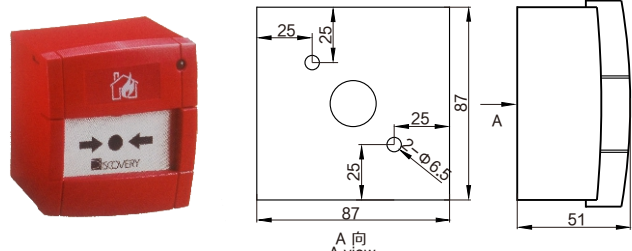

颜色Color: 红色black(RAL 3020)
防护等级 IP class:IP24
重量 Weight:160g

58100-976MAR防水手动报警按钮 Explosion-proof manually call point 55100-940APO防爆手动报警按钮 Waterproof manually call point

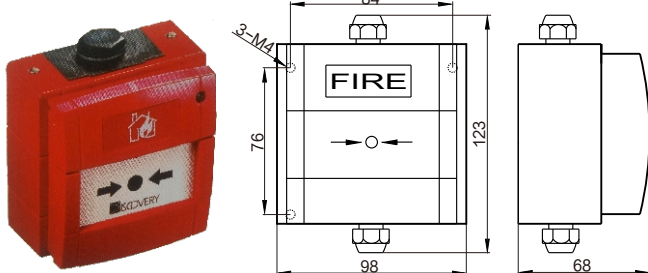

颜色Color: 红色black(RAL 3020)
防护等级 IP class:IP67
重量 Weight:160/240g

58100-976MAR
重量 Weight:160g
填料函进线孔径 Stuffing box cable entrance hole size: 2-Φ12mm

58100-940APO
重量 Weight:240g
防爆等级Explosion-proof class:Exia II C T5
填料函进线孔径 Stuffing box cable entrance hole size: 3-Φ12mm

Syncro火灾报警系统接线示意图
Syncro fire alarm system connection diagram

